

## Suction cups VAS/VASB

**FESTO**



Festo core product range  
Covers 80% of your automation tasks

Worldwide:

Always in stock

Superb:

Festo quality at an attractive price

Easy:

Reduces procurement and storing complexity

★ Ready for dispatch from the Festo factory in 24 hours  
Held in stock in 13 service centres worldwide  
More than 2200 products

★ Ready for dispatch in 5 days maximum from stock  
Assembled for you in 4 service centres worldwide  
Up to 6 x 10<sup>12</sup> variants per product series

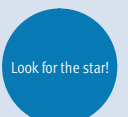

# Suction cups VAS/VASB

Key features



## Product overview

Festo suction grippers offer outstanding functionality and quality.

An extensive, modular range of suction cups with connection attachments, in different shapes, materials and sizes, plus a wide selection of

suction cup holders, angle and height compensators and vacuum filters within the modular suction gripper

system, provide users with a huge range of possible combinations for a wide variety of applications.

## Suction grippers ESG

Modular products with over 2000 variants

Technical data → Internet: [esg](#)

- The ideal solution for the transport of workpieces of different weights, surfaces and shapes
- Choose from:
  - 15 suction cup diameters
  - 6 different materials – including antistatic types
  - 6 suction cup shapes
  - Numerous suction cup holders
  - Optional accessories (vacuum filters and angle compensators)
- Wide range of variants
- A suitable solution for every task
- Wide range to suit applications with various temperature ranges and workpiece surfaces
- Suction cups made from silicone are food-safe

## Suction gripper as a complete solution

## Suction gripper made of individual components

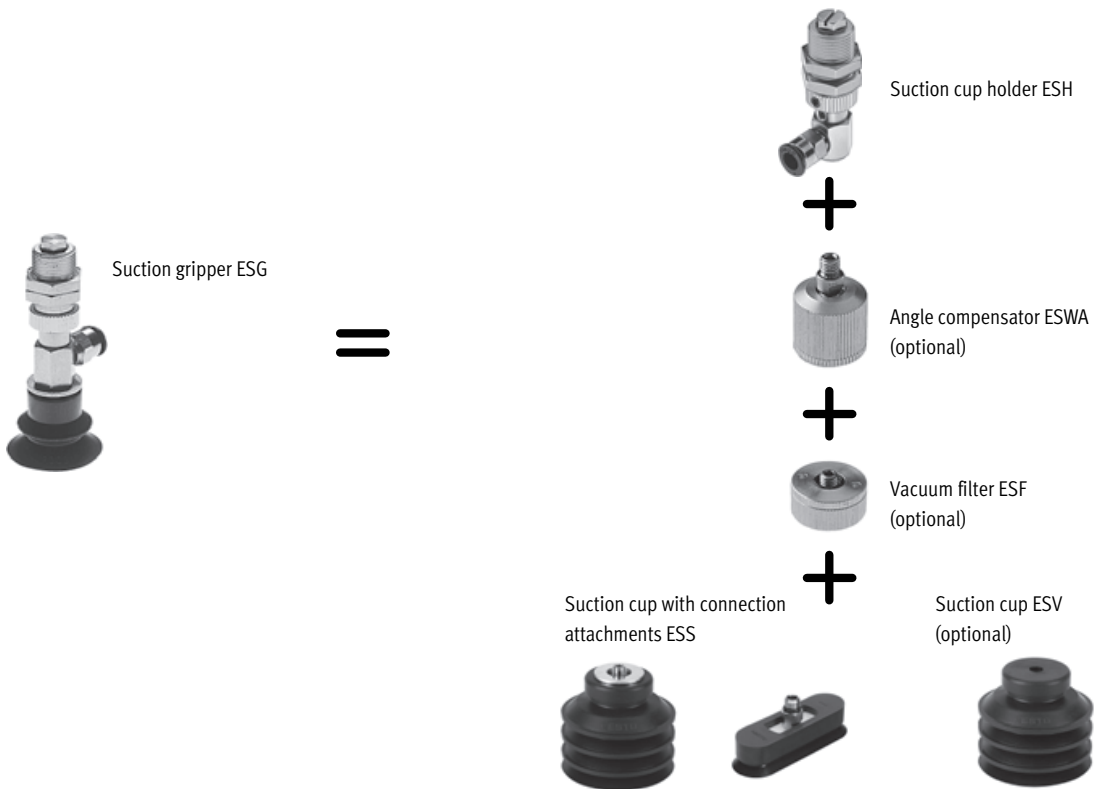

# Suction cups VAS/VASB

Key features

FESTO

## Suction cups VAS/VASB

Sturdy and reliable

- The ideal solution for the transport of workpieces of different weights, surfaces and shapes
- Choose from:
  - 11 suction cup diameters
  - 2 suction cup shapes: round and bellows design
  - 3 materials: nitrile rubber, polyurethane and silicone for use in a wide variety of applications
- Wide range to suit applications with various temperature ranges and workpiece surfaces
- Suction cups made from silicone are food-safe
- All tubing connector sizes correspond to a holder size



# Suction cups VAS/VASB

Features

## Suction cups with fixed connecting thread

- VAS: 2 ... 125 mm diameter
- VASB: 8 ... 125 mm diameter
- Suction retention of workpieces with smooth, impervious surfaces
- Bellows suction cups can adapt to suit uneven, curved and inclined surfaces

### Nitrile rubber (NBR)

- Can be used universally

### Polyurethane (PUR)

- Long service life
- Gentle handling with soft suction cup material

### Silicone (SI)

- Excellent thermal resistance
- Food-safe



## Accessories

### Vacuum security valve ISV

Technical data → Internet: isv

- Vacuum does not dissipate when any of several suction cups arranged in parallel fail to maintain contact
- Saves compressed air and energy



### Height compensator VAL

Technical data → Internet: val

- Gentle handling of the workpieces by compensating for tolerance differences in the workpiece thickness.



### Elbow fitting LJK

Technical data → Internet: ljk

- Redirection of air connection
- Swivel joint rotatable 360°



### Adapter AD

Technical data → Internet: ad

- For connection of suction cup with piston rod thread, for example



## Vacuum technology can be used in a wide range of applications

- Lifting
- Placing
- Moving
- Insertion
- Conveying
- Gripping
- Holding
- Loading
- Clamping
- Transporting
- Repositioning
- Turning

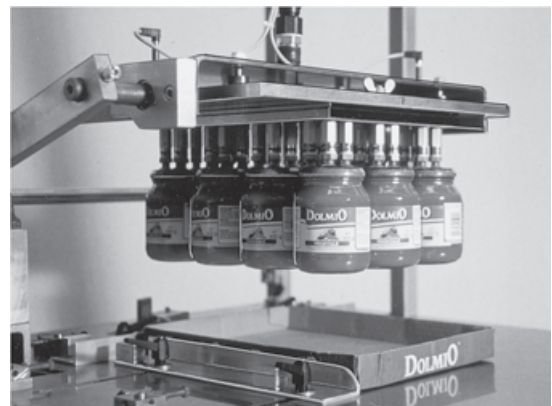

Flexible automation technology is an important field of application for vacuum technology:

- Small, mid-sized and large series manufacturing
- Assembly
- Conveyor and packaging technology

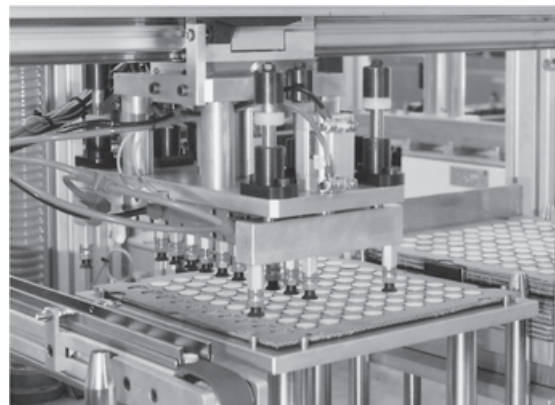

# Suction cups VAS/VASB

Product range overview

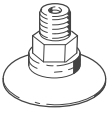
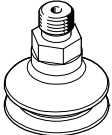

Design	Version	Type	Suction cup diameter	Type of mounting	Vacuum port	Suction cup materials	→ Page/ Internet
Round, flat	<b>Vacuum port on side</b>						
		VAS	8	M5	PK-3	TPE-U(PU)	6
	<b>Vacuum port on top</b>						
		VAS	2, 5, 8, 10, 15, 30, 40, 55, 75, 100, 125	M3, M5, G1/8, G1/4, G3/8	M3, M5, G1/8, G1/4, G3/8	NBR	8
			8, 10, 15, 30, 40, 55, 75, 100, 125	M5, G1/8, G1/4, G3/8	M5, G1/8, G1/4, G3/8	VMQ (silicone)	12
			8, 10, 15, 30, 40, 55, 75, 100, 125	M5, G1/8, G1/4, G3/8	M5, G1/8, G1/4, G3/8	PUR	12
Round, bellows, 1.5 convolutions	<b>Vacuum port on top</b>						
		VASB	8, 15, 30, 40, 55, 75, 100, 125	M5, G1/8, G1/4, G3/8	M5, G1/8, G1/4, G3/8	NBR	16
			8, 15, 30, 40, 55, 75, 100, 125	M5, G1/8, G1/4, G3/8	M5, G1/8, G1/4, G3/8	VMQ (silicone)	20
		8, 15, 30, 40, 55, 75, 100, 125	M5, G1/8, G1/4, G3/8	M5, G1/8, G1/4, G3/8	PUR	20	

# Suction cups VAS-...-S-PUR-B, vacuum port on side

Technical data

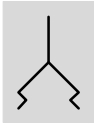
Function



-  Diameter  
8 mm
-  Temperature range  
-20 ... +60 °C



General technical data		
Suction cup diameter	[mm]	8
Vacuum connection		PK-3
Connection position		On side
Nominal size	[mm]	2
Design		Round, flat
Type of mounting		M5
Mounting position		Any
Nominal operating pressure	[bar]	-0.7
Holding force at nominal operating pressure -0.7 bar	[N]	2.8
Effective suction cup diameter	[mm]	7.1
Suction cup volume	[cm <sup>3</sup> ]	0.095

Operating and environmental conditions		
Operating pressure	[bar]	-0.95 ... 0
Operating medium		Atmospheric air based on ISO 8573-1:2010 [7:-:-]
Ambient temperature	[°C]	-20 ... +60
Corrosion resistance class CRC <sup>1)</sup>		2

1) CRC2: Corrosion resistance class to Festo standard 940 070  
Components with medium corrosion exposure. Externally visible components with significant decorative function in direct contact with normal industrial atmosphere or media such as coolants and lubricants.

Materials	
Shore hardness	60 ±5
Suction cup	TPE-U(PU) Colour: blue
Threaded plug	Brass
Note on materials	RoHS-compliant

# Suction cups VAS-...-S-PUR-B, vacuum port on side

Technical data

**Dimensions**

Download CAD data → [www.festo.com](http://www.festo.com)

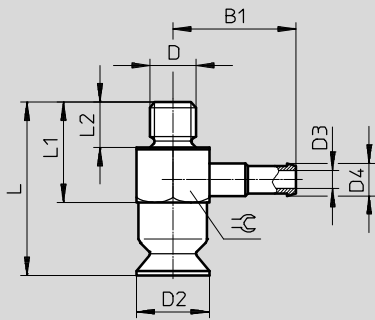

Type	B1	D	D2	D3	D4	L	L1	L2	∅
VAS-8-...-S-PUR-B	13.5	M5	8	2	3.6	19	11.5	5	8

**Ordering data**

Suction cup diameter [mm]	Vacuum port	Weight [g]	Part No.	Type
8	PK-3	4	8025969	VAS-8-M5-S-PUR-B

# Suction cups VAS-...-NBR

Type codes

FESTO

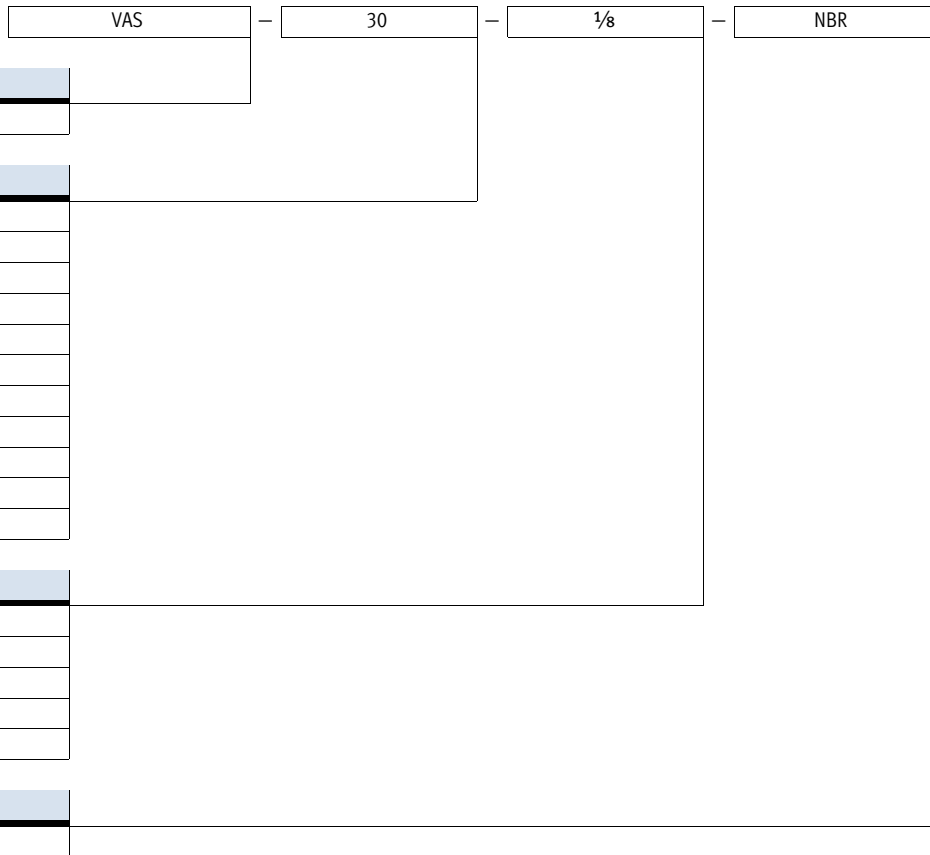

Type	
VAS	Suction cup

Suction cup diameter [mm]	
2	2
5	5
8	8
10	10
15	15
30	30
40	40
55	55
75	75
100	100
125	125

Vacuum port	
M3	Thread M3
M5	Thread M5
1/8	Thread G1/8
1/4	Thread G1/4
3/8	Thread G3/8

Materials	
NBR	Nitrile rubber

-  - Note  
Possible combinations can be found in the ordering data.





# Suction cups VAS-...-NBR

Technical data

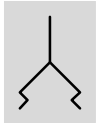
Function



-  Diameter  
2 ... 125 mm
-  Temperature range  
-20 ... +80 °C



General technical data												
Suction cup diameter [mm]	2	5	8	10	15	30	40	55	75	100	125	
Vacuum connection	M3	M5	M5	M5	G1/8	G1/8	G1/4	G1/4	G1/4	G1/4	G1/4	G3/8
Connection position	On top											
Nominal size [mm]	1	1.5	2	2	3	3	4	4	4	4	4	7
Design	Round, flat											
Type of mounting	Via vacuum connection											
Mounting position	Any											
Nominal operating pressure [bar]	-0.7											
Holding force at nominal operating pressure -0.7 bar [N]	0.14	0.9	1.6	4.5	7.9	34	56	106	197	397	606	
Effective suction cup diameter [mm]	1.6	4	5.5	8	12	25	32	44	60	85	105	
Suction cup volume [cm <sup>3</sup> ]	0.03	0.03	0.095	0.12	0.328	1.29	3.47	8.01	18.3	33.5	79.1	
Height compensation [mm]	0.5	0.5	0.9	1.1	1.2	1.9	3	3.5	3.5	3.5	6	

Operating and environmental conditions	
Type	VAS-...-NBR
Operating pressure [bar]	-0.95 ... 0
Operating medium	Atmospheric air based on ISO 8573-1:2010 [7:-:-]
Ambient temperature [°C]	-20 ... +80
Corrosion resistance class CRC <sup>1)</sup>	2

1) CRC2: Corrosion resistance class to Festo standard 940 070  
Components with medium corrosion exposure. Externally visible components with significant decorative function in direct contact with normal industrial atmosphere or media such as coolants and lubricants.

Materials	
Type	VAS-...-NBR
Shore hardness	55 ±5 (suction cup diameter 2 ... 5 mm)
	60 ±5 (suction cup diameter 8 ... 15 mm)
	70 ±5 (suction cup diameter 30 ... 125 mm)
Suction cup	NBR Colour: black
Threaded plug	High-alloy steel (suction cup diameter 2 mm)
	Wrought aluminium alloy (suction cup diameter 5 and 10 mm)
	Brass (suction cup diameter 8, 15 and 30 mm)
	Die-cast zinc (suction cup diameter 40 ... 125 mm)
Note on materials	RoHS-compliant

# Suction cups VAS-...-NBR

Technical data

## Theoretical suction force F as a function of vacuum $p_u$

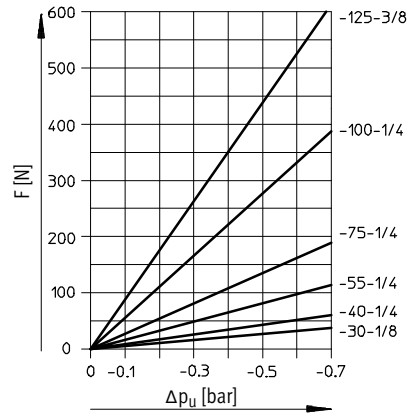
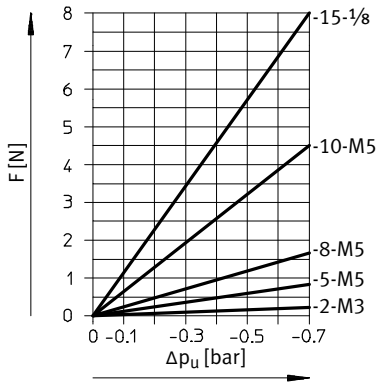

## Suction cup volume

VAS-8

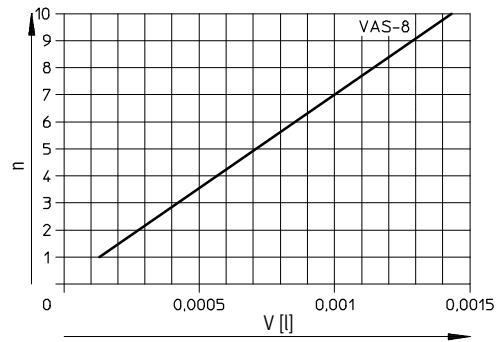

VAS-15 ... 100

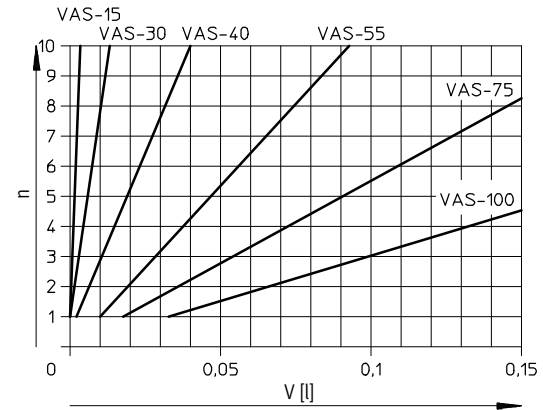

VAS-125

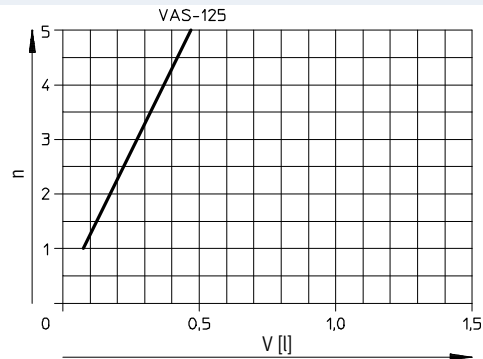

# Suction cups VAS-...-NBR

Technical data

FESTO

## Dimensions

Download CAD data → [www.festo.com](http://www.festo.com)

VAS-...-NBR

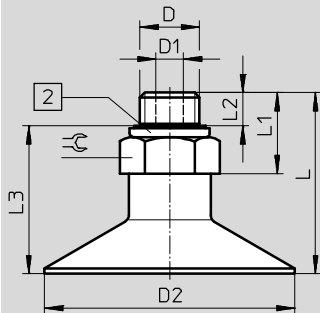

2 VAS-5/10:  
Sealing ring OK  
VAS-8/15 ... 125:  
Sealing ring OL

Type	Connection D	D1 ∅	D2 ∅	L	L1	L2	L3	⊕
VAS-2-...-NBR <sup>1)</sup>	M3	1	2	9.4	5.4	3.3	6.1	4.5
VAS-5-...-NBR	M5	2	5	16.5	10	3.8	12.7	8
VAS-8-...-NBR	M5	2	8	19	11.3	2.85	16.15	8
VAS-10-...-NBR	M5	2	10	19.2	11.5	3.8	15.4	8
VAS-15-...-NBR	G1/8	3	15	20.2	12	4.7	15.5	13
VAS-30-...-NBR	G1/8	3	30	21.5	12	4.7	16.8	13
VAS-40-...-NBR	G1/4	4	40	30.9	17.4	5.8	25.1	17
VAS-55-...-NBR	G1/4	4	55	33.9	17.4	5.8	28.1	17
VAS-75-...-NBR	G1/4	4	75	28	17	5.8	22.2	17
VAS-100-...-NBR	G1/4	4	100	28	17	5.8	22.2	17
VAS-125-...-NBR	G3/8	7	125	36	20	6.05	29.95	19

1) Sealing ring is not included in the scope of delivery.

## ★ Core product range

Ordering data				
Suction cup diameter [mm]	Vacuum port	Weight [g]	Part No.	Type
30	G1/8	13	★ 34587	VAS-30-1/8-NBR

Ordering data				
Suction cup diameter [mm]	Vacuum port	Weight [g]	Part No.	Type
2	M3	1	173438	VAS-2-M3-NBR
5	M5	2	173439	VAS-5-M5-NBR
8	M5	4	34588	VAS-8-M5-NBR
10	M5	3	173440	VAS-10-M5-NBR
15	G1/8	11	36142	VAS-15-1/8-NBR
40	G1/4	26	36143	VAS-40-1/4-NBR
55	G1/4	32	36144	VAS-55-1/4-NBR
75	G1/4	76	36145	VAS-75-1/4-NBR
100	G1/4	138	34586	VAS-100-1/4-NBR
125	G3/8	152	152605	VAS-125-3/8-NBR

Festo core product range

- ★ Ready for dispatch from the Festo factory in 24 hours
- ★ Ready for dispatch in 5 days maximum from stock

# Suction cups VAS-...-SI-B/PUR-B

Type codes

VAS - 30 - 1/8 - PUR - B

Type	
VAS	Suction cup

Suction cup diameter [mm]	
8	8
10	10
15	15
30	30
40	40
55	55
75	75
100	100
125	125

Vacuum port	
M5	Thread M5
1/8	Thread G1/8
1/4	Thread G1/4
3/8	Thread G3/8

Materials	
SI	VMQ (silicone)
PUR	Polyurethane

Generation	
B	B series

-  - Note  
Possible combinations can be found in the ordering data.

# Suction cups VAS-...-SI-B/PUR-B

Technical data

Function

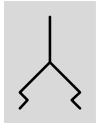

- Diameter  
8 ... 125 mm
- Temperature range  
-40 ... +200 °C



General technical data										
Suction cup diameter	[mm]	8	10	15	30	40	55	75	100	125
Vacuum connection		M5	M5	G1/8	G1/8	G1/4	G1/4	G1/4	G1/4	G3/8
Connection position		On top								
Nominal size	[mm]	2	2	3	3	4	4	4	4	7
Design		Round, flat								
Type of mounting		Via vacuum connection								
Mounting position		Any								
Nominal operating pressure	[bar]	-0.7								
Holding force at nominal operating pressure -0.7 bar	[N]	SI: 2.6 PUR: 2.8	SI: 3.7 PUR: 4	8.5	SI: 31 PUR: 34	SI: 58 PUR: 60	110	SI: 245 PUR: 250	SI: 464 PUR: 450	SI: 700 PUR: 570
Suction cup volume	[cm <sup>3</sup> ]	0.095	0.12	0.328	1.29	3.47	8.01	18.3	33.5	79.1
Height compensation	[mm]	0.9	1.1	1.2	1.9	3	3.5	3.5	3.5	6

Operating and environmental conditions		
Type	VAS-...-SI-B	VAS-...-PUR-B
Operating pressure	[bar] -0.95 ... 0	
Operating medium	Atmospheric air based on ISO 8573-1:2010 [7:-:-]	
Ambient temperature	[°C] -40 ... +200	-20 ... +60
Corrosion resistance class CRC <sup>1)</sup>	2	
Food-safe <sup>2)</sup>	See supplementary material information	-

- 1) Corrosion resistance class CRC 2 to Festo standard FN 940070  
Moderate corrosion stress. Indoor applications in which condensation may occur. External visible parts with primarily decorative requirements for the surface and which are in direct contact with the ambient atmosphere typical for industrial applications.
- 2) Additional information [www.festo.com/sp](http://www.festo.com/sp) → Certificates.

Materials		
Type	VAS-...-SI-B	VAS-...-PUR-B
Shore hardness	60 ±5	
Suction cup	VMQ (silicone) Colour: transparent	PUR Colour: blue
Threaded plug	Wrought aluminium alloy	Brass (suction cup diameter 8 ... 30 mm) Die-cast zinc (suction cup diameter 40 ... 125 mm)
Note on materials	RoHS-compliant Contains PWIS (paint wetting impairment substances)	-

# Suction cups VAS-...-SI-B/PUR-B

Technical data

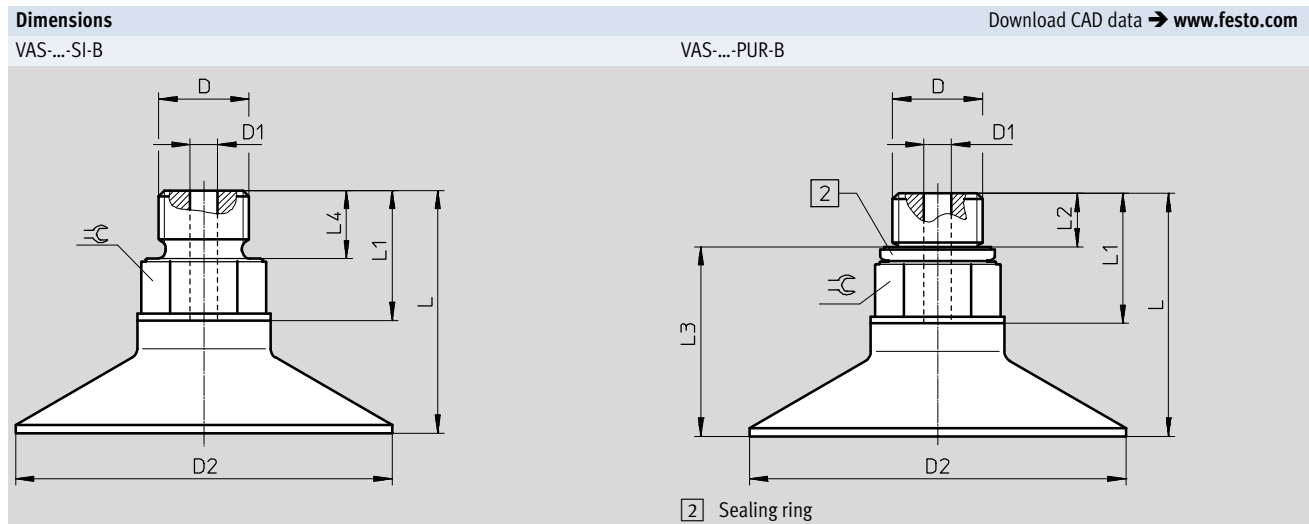

Type	Connection D	D1 Ø	D2 Ø	L	L1	L2	L3	L4	⌀
VAS-8-...-SI-B	M5	2	8	19.2	11.5	-	-	4.3	8
VAS-10-...-SI-B	M5	2	10	19.2	11.5	-	-	4.3	8
VAS-15-...-SI-B	G1/8	3	15	20	12	-	-	6.5	13
VAS-30-...-SI-B	G1/8	3	30	21.5	12	-	-	6.5	13
VAS-40-...-SI-B	G1/4	4	40	30.5	17	-	-	8	17
VAS-55-...-SI-B	G1/4	4	55	33.5	17	-	-	8	17
VAS-75-...-SI-B	G1/4	4	75	28.2	17	-	-	8	17
VAS-100-...-SI-B	G1/4	4	100	28	17	-	-	8	17
VAS-125-...-SI-B	G3/8	7	125	36	20	-	-	12	19
VAS-8-...-PUR-B	M5	2	8	19	11.3	2.85	16.15	-	8
VAS-10-...-PUR-B	M5	2	10	19.2	11.5	2.85	16.35	-	8
VAS-15-...-PUR-B	G1/8	3	15	20	12	4.7	15.3	-	13
VAS-30-...-PUR-B	G1/8	3	30	21.5	12	4.7	16.8	-	13
VAS-40-...-PUR-B	G1/4	4	40	29.5	17	5.8	23.7	-	17
VAS-55-...-PUR-B	G1/4	4	55	32.5	17	5.8	26.7	-	17
VAS-75-...-PUR-B	G1/4	4	75	28	17	5.8	22.2	-	17
VAS-100-...-PUR-B	G1/4	4	100	28	17	5.8	22.2	-	17
VAS-125-...-PUR-B	G3/8	7	125	36	20	6.45	29.55	-	19

# Suction cups VAS-...-SI-B/PUR-B

Technical data

★ Core product range

Ordering data				
Suction cup diameter [mm]	Vacuum port	Weight [g]	Part No.	Type
VMQ (silicone)				
15	G $\frac{1}{8}$	4	★ 1376604	VAS-15- $\frac{1}{8}$ -SI-B
30	G $\frac{1}{8}$	5	★ 1377752	VAS-30- $\frac{1}{8}$ -SI-B
Polyurethane				
40	G $\frac{1}{4}$	26	★ 1396092	VAS-40- $\frac{1}{4}$ -PUR-B

Ordering data				
Suction cup diameter [mm]	Vacuum port	Weight [g]	Part No.	Type
VMQ (silicone)				
8	M5	2	1377781	VAS-8-M5-SI-B
10	M5	2	1385610	VAS-10-M5-SI-B
40	G $\frac{1}{4}$	14	1379454	VAS-40- $\frac{1}{4}$ -SI-B
55	G $\frac{1}{4}$	19	1379348	VAS-55- $\frac{1}{4}$ -SI-B
75	G $\frac{1}{4}$	62	1382165	VAS-75- $\frac{1}{4}$ -SI-B
100	G $\frac{1}{4}$	116	1386376	VAS-100- $\frac{1}{4}$ -SI-B
125	G $\frac{3}{8}$	214	1415120	VAS-125- $\frac{3}{8}$ -SI-B
Polyurethane				
8	M5	4	1396086	VAS-8-M5-PUR-B
10	M5	4	1469698	VAS-10-M5-PUR-B
15	G $\frac{1}{8}$	11	1396087	VAS-15- $\frac{1}{8}$ -PUR-B
30	G $\frac{1}{8}$	12	1396090	VAS-30- $\frac{1}{8}$ -PUR-B
55	G $\frac{1}{4}$	30	1396095	VAS-55- $\frac{1}{4}$ -PUR-B
75	G $\frac{1}{4}$	77	1396096	VAS-75- $\frac{1}{4}$ -PUR-B
100	G $\frac{1}{4}$	140	1396098	VAS-100- $\frac{1}{4}$ -PUR-B
125	G $\frac{3}{8}$	249	1396108	VAS-125- $\frac{3}{8}$ -PUR-B

Festo core product range

- ★ Ready for dispatch from the Festo factory in 24 hours
- ★ Ready for dispatch in 5 days maximum from stock

# Suction cups VASB-...-NBR, bellows

Type codes

VASB - 30 - 1/8 - NBR

Type	
VASB	Suction cup

Suction cup diameter [mm]	
8	8
15	15
30	30
40	40
55	55
75	75
100	100
125	125

Vacuum port	
M5	Thread M5
1/8	Thread G1/8
1/4	Thread G1/4
3/8	Thread G3/8

Materials	
NBR	Nitrile rubber

-  - Note  
Possible combinations can be found in the ordering data.





# Suction cups VASB-...-NBR, bellows

Technical data

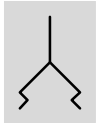
Function



-  Diameter  
8 ... 125 mm
-  Temperature range  
-20 ... +80 °C

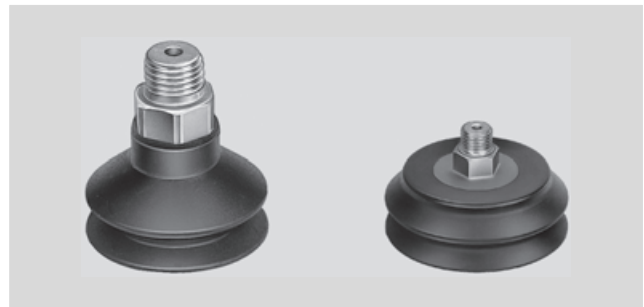

General technical data									
Suction cup diameter	[mm]	8	15	30	40	55	75	100	125
Vacuum connection		M5	G1/8	G1/8	G1/4	G1/4	G1/4	G1/4	G3/8
Connection position		On top							
Nominal size	[mm]	2	3	3	4	4	4	4	7
Design		Round, bellows, 1.5 convolutions							
Type of mounting		Via vacuum connection							
Mounting position		Any							
Nominal operating pressure	[bar]	-0.7							
Holding force at nominal operating pressure -0.7 bar	[N]	1.6	7.9	34	56	106	197	397	606
Effective suction cup diameter	[mm]	5.5	12	25	32	44	60	85	105
Suction cup volume	[cm <sup>3</sup> ]	0.163	0.83	6.18	11.11	30.4	65.5	128	307
Height compensation	[mm]	3.3	5.6	13.9	13.7	20	15.5	15.5	25

Operating and environmental conditions	
Type	VASB-...-NBR
Operating pressure	[bar] -0.95 ... 0
Operating medium	Atmospheric air based on ISO 8573-1:2010 [7:-:-]
Ambient temperature	[°C] -20 ... +80
Corrosion resistance class CRC <sup>1)</sup>	2

1) CRC2: Corrosion resistance class to Festo standard 940 070  
Components with medium corrosion exposure. Externally visible components with significant decorative function in direct contact with normal industrial atmosphere or media such as coolants and lubricants.

Materials	
Type	VASB-...-NBR
Shore hardness	60 ±5
Suction cup	NBR Colour: black
Threaded plug	Brass (suction cup diameter 8 ... 30 mm) Die-cast zinc (suction cup diameter 40 ... 125 mm)
Note on materials	RoHS-compliant

# Suction cups VASB-...-NBR, bellows

Technical data

Theoretical suction force F as a function of vacuum  $p_u$

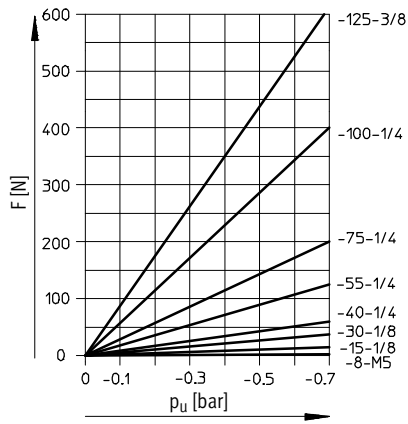

Suction cup volume

VASB-8

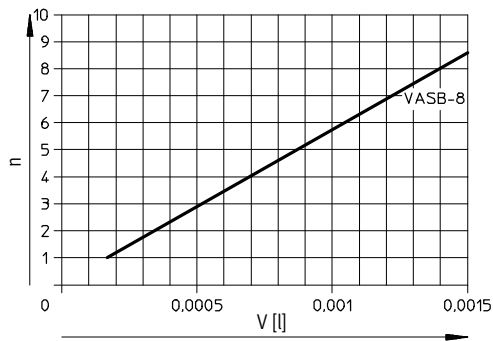

VASB-15 ... 100

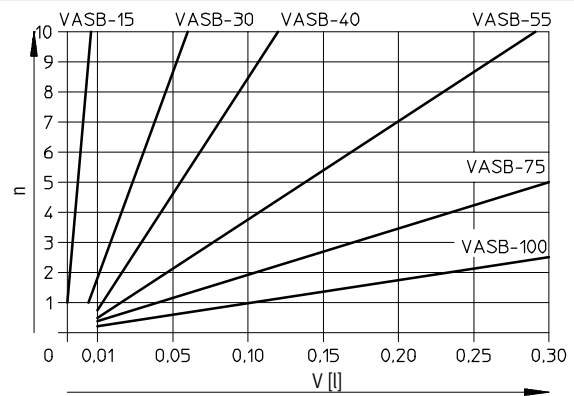

VASB-125

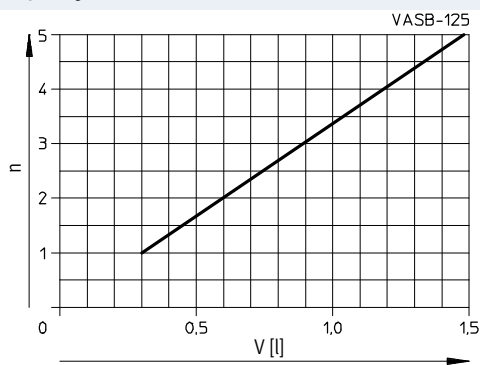

# Suction cups VASB-...-NBR, bellows

Technical data

FESTO

## Dimensions

Download CAD data → [www.festo.com](http://www.festo.com)

VASB-...-NBR

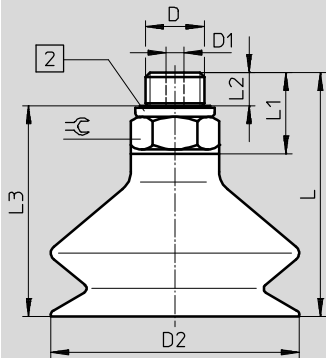

2 Sealing ring OL

Type	Connection D	D1 ∅	D2 ∅	L	L1	L2	L3	☉
VASB-8-...-NBR	M5	2	8	22.5	11.3	2.85	19.65	8
VASB-15-...-NBR	G1/8	3	15	25.2	12	4.7	20.5	13
VASB-30-...-NBR	G1/8	3	30	34.3	12	4.7	29.6	13
VASB-40-...-NBR	G1/4	4	40	43.4	17.4	5.8	37.6	17
VASB-55-...-NBR	G1/4	4	55	52.4	17.4	5.8	46.6	17
VASB-75-...-NBR	G1/4	4	75	43.5	17	5.8	37.7	17
VASB-100-...-NBR	G1/4	4	100	44	17	5.8	38.2	17
VASB-125-...-NBR	G3/8	7	125	60	20	6	54	19

## Ordering data

Suction cup diameter [mm]	Vacuum port	Weight [g]	Part No.	Type
8	M5	4	35410	VASB-8-M5-NBR
15	G1/8	11	35411	VASB-15-1/8-NBR
30	G1/8	15	35412	VASB-30-1/8-NBR
40	G1/4	30	35413	VASB-40-1/4-NBR
55	G1/4	42	35414	VASB-55-1/4-NBR
75	G1/4	95	35415	VASB-75-1/4-NBR
100	G1/4	170	35416	VASB-100-1/4-NBR
125	G3/8	207	152609	VASB-125-3/8-NBR

# Suction cups VASB-...-SI-B/PUR-B, bellows

Type codes



VASB – 30 – 1/8 – PUR – B

Type	
VASB	Suction cup

Suction cup diameter [mm]	
8	8
15	15
30	30
40	40
55	55
75	75
100	100
125	125

Vacuum port	
M5	Thread M5
1/8	Thread G1/8
1/4	Thread G1/4
3/8	Thread G3/8

Materials	
SI	VMQ (silicone)
PUR	Polyurethane

Generation	
B	B series



-  - Note  
Possible combinations can be found in the ordering data.

# Suction cups VASB-...-SI-B/PUR-B, bellows

Technical data

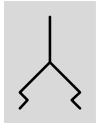
Function



-  Diameter  
8 ... 125 mm
-  Temperature range  
-40 ... +200 °C



General technical data									
Suction cup diameter	[mm]	8	15	30	40	55	75	100	125
Vacuum connection		M5	G1/8	G1/8	G1/4	G1/4	G1/4	G1/4	G3/8
Connection position		On top							
Nominal size	[mm]	2	3	3	4	4	4	4	7
Design		Round, bellows, 1.5 convolutions							
Type of mounting		Via vacuum connection							
Mounting position		Any							
Nominal operating pressure	[bar]	-0.7							
Holding force at nominal operating pressure -0.7 bar	[N]	SI: 2.6 PUR: 2.8	8.5	SI: 25 PUR: 34	SI: 58 PUR: 60	110	SI: 228 PUR: 250	SI: 395 PUR: 450	SI: 610 PUR: 570
Suction cup volume	[cm <sup>3</sup> ]	0.163	0.83	6.18	11.11	30.4	65.5	128	307
Height compensation	[mm]	3.3	5.6	13.9	13.7	20	15.5	15.5	25

Operating and environmental conditions		
Type	VASB-...-SI-B	VASB-...-PUR-B
Operating pressure	[bar] -0.95 ... 0	
Operating medium	Atmospheric air based on ISO 8573-1:2010 [7:-:-]	
Ambient temperature	[°C] -40 ... +200	-20 ... +60
Corrosion resistance class CRC <sup>1)</sup>	2	
Food-safe <sup>2)</sup>	See supplementary material information	-

- 1) Corrosion resistance class CRC 2 to Festo standard FN 940070  
Moderate corrosion stress. Indoor applications in which condensation may occur. External visible parts with primarily decorative requirements for the surface and which are in direct contact with the ambient atmosphere typical for industrial applications.
- 2) Additional information [www.festo.com/sp](http://www.festo.com/sp) → Certificates.

Materials		
Type	VASB-...-SI-B	VASB-...-PUR-B
Shore hardness	60 ±5	
Suction cup	VMQ (silicone) Colour: transparent	PUR Colour: blue
Threaded plug	Wrought aluminium alloy	Brass (suction cup diameter 8 ... 30 mm) Die-cast zinc (suction cup diameter 40 ... 125 mm)
Note on materials	RoHS-compliant Contains PWIS (paint wetting impairment substances)	-

# Suction cups VASB-...-SI-B/PUR-B, bellows

Technical data

Dimensions Download CAD data → [www.festo.com](http://www.festo.com)

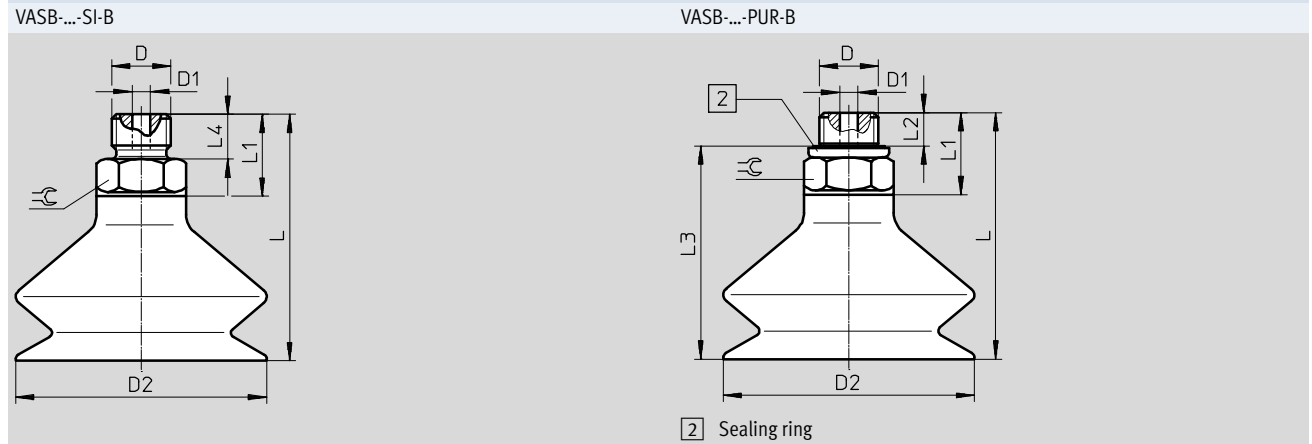

Type	Connection D	D1 Ø	D2 Ø	L	L1	L2	L3	L4	⌀
VASB-8-...-SI-B	M5	2	8	22.5	11.5	-	-	4.3	8
VASB-15-...-SI-B	G1/8	3	15	25.5	12	-	-	6.5	13
VASB-30-...-SI-B	G1/8	3	30	34	12	-	-	6.5	13
VASB-40-...-SI-B	G1/4	4	40	43	17	-	-	8	17
VASB-55-...-SI-B	G1/4	4	55	52	17	-	-	8	17
VASB-75-...-SI-B	G1/4	4	75	43.7	14.2	-	-	8	17
VASB-100-...-SI-B	G1/4	4	100	43.7	14.2	-	-	8	17
VASB-125-...-SI-B	G3/8	7	125	60	16.4	-	-	9	19
VASB-8-...-PUR-B	M5	2	8	22.5	11.5	3.55	18.95	-	8
VASB-15-...-PUR-B	G1/8	3	15	25.5	12	4.7	20.8	-	13
VASB-30-...-PUR-B	G1/8	3	30	34	12	4.7	29.3	-	13
VASB-40-...-PUR-B	G1/4	4	40	43	17	5.8	37.2	-	17
VASB-55-...-PUR-B	G1/4	4	55	52	17	5.8	46.2	-	17
VASB-75-...-PUR-B	G1/4	4	75	43.5	17	5.8	37.7	-	17
VASB-100-...-PUR-B	G1/4	4	100	43.5	17	5.8	37.7	-	17
VASB-125-...-PUR-B	G3/8	7	125	60	20	6	54	-	19

# Suction cups VASB-...-SI-B/PUR-B, bellows

FESTO

Technical data

## ★ Core product range

Ordering data				
Suction cup diameter [mm]	Vacuum port	Weight [g]	Part No.	Type
VMQ (silicone)				
15	G $\frac{1}{8}$	4	★ 1377689	VASB-15- $\frac{1}{8}$ -SI-B
Polyurethane				
55	G $\frac{1}{4}$	39	★ 1396063	VASB-55- $\frac{1}{4}$ -PUR-B

Ordering data				
Suction cup diameter [mm]	Vacuum port	Weight [g]	Part No.	Type
VMQ (silicone)				
8	M5	2	1394696	VASB-8-M5-SI-B
30	G $\frac{1}{8}$	7	1377637	VASB-30- $\frac{1}{8}$ -SI-B
40	G $\frac{1}{4}$	18	1372910	VASB-40- $\frac{1}{4}$ -SI-B
55	G $\frac{1}{4}$	29	1373812	VASB-55- $\frac{1}{4}$ -SI-B
75	G $\frac{1}{4}$	78	1378427	VASB-75- $\frac{1}{4}$ -SI-B
100	G $\frac{1}{4}$	132	1382277	VASB-100- $\frac{1}{4}$ -SI-B
125	G $\frac{3}{8}$	247	1387375	VASB-125- $\frac{3}{8}$ -SI-B
Polyurethane				
8	M5	4	1395637	VASB-8-M5-PUR-B
15	G $\frac{1}{8}$	11	1395671	VASB-15- $\frac{1}{8}$ -PUR-B
30	G $\frac{1}{8}$	14	1395690	VASB-30- $\frac{1}{8}$ -PUR-B
40	G $\frac{1}{4}$	30	1395691	VASB-40- $\frac{1}{4}$ -PUR-B
75	G $\frac{1}{4}$	90	1396064	VASB-75- $\frac{1}{4}$ -PUR-B
100	G $\frac{1}{4}$	155	1396066	VASB-100- $\frac{1}{4}$ -PUR-B
125	G $\frac{3}{8}$	294	1396067	VASB-125- $\frac{3}{8}$ -PUR-B

Festo core product range

★ Ready for dispatch from the Festo factory in 24 hours

★ Ready for dispatch in 5 days maximum from stock

# Festo - Your Partner in Automation



**1 Festo Inc.**  
5300 Explorer Drive  
Mississauga, ON L4W 5G4  
Canada

**Festo Customer Interaction Center**  
Tel: 1 877 463 3786  
Fax: 1 877 393 3786  
Email: [customer.service.ca@festo.com](mailto:customer.service.ca@festo.com)



**2 Festo Pneumatic**  
Av. Ceylán 3,  
Col. Tequesquináhuac  
54020 Tlalneptla,  
Estado de México

**Multinational Contact Center**  
01 800 337 8669  
[ventas.mexico@festo.com](mailto:ventas.mexico@festo.com)



**3 Festo Corporation**  
1377 Motor Parkway  
Suite 310  
Islandia, NY 11749

**Festo Customer Interaction Center**  
1 800 993 3786  
1 800 963 3786  
[customer.service.us@festo.com](mailto:customer.service.us@festo.com)



**4 Regional Service Center**  
7777 Columbia Road  
Mason, OH 45040

Connect with us



[www.festo.com/socialmedia](http://www.festo.com/socialmedia)



[www.festo.com](http://www.festo.com)

Subject to change