

Mercotac[®]

Superior Connections for a World in Motion



C
A
T
A
L
O
G

MOD-TRONIC
INSTRUMENTS LIMITED

1 Delta Park Blvd, #12 Brampton, ON L6T 5G1
Tel 905-457-6322 or 1-800-794-5883
Fax 905-457-4716 or 1-800-830-7122
sales@mod-tronic.com www.mod-tronic.com

Do you want a superior connection or an ordinary slip ring?

The choice is yours.

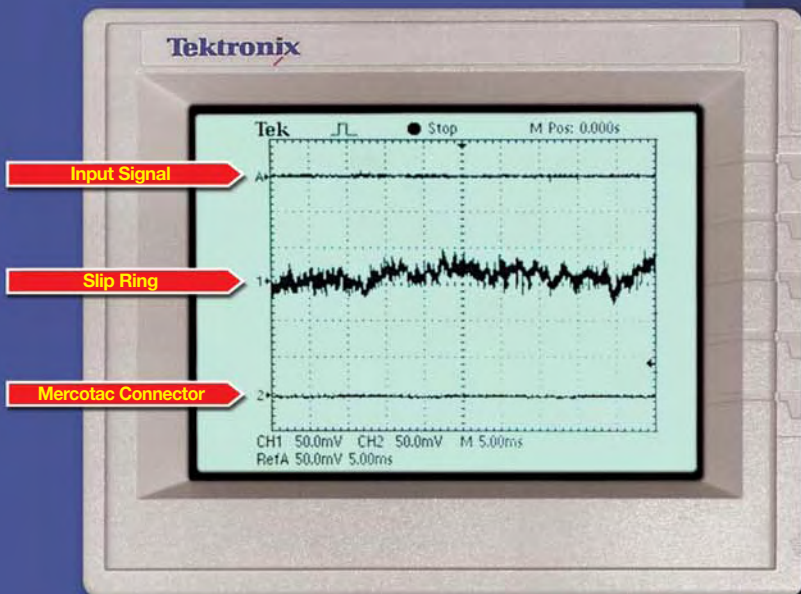

- Superior to Conventional Slip Rings
- Extremely Low Electrical Noise
- Less Than One Milliohm Resistance
- Durable, Compact, Low Cost

There are many ways you will profit by using Mercotac connectors:

Slip rings require maintenance and lose signal quality over time due to wear and debris. **Mercotac connectors are maintenance free**, do not degrade the signal over time and last much longer than slip rings.

Slip rings introduce electrical noise into the signal being transmitted. **Mercotac connectors transmit with near zero electrical noise**, thus the same connector can be used for power and signal transmission.

Slip rings typically last several million revolutions. **Mercotac connectors typically last hundreds of millions of revolutions. In many applications they can last over a billion revolutions.**

Though superior in performance and durability, **Mercotac connectors cost less than slip rings** of comparable capacity.

The above **superior performance is possible** because of the unique design feature of Mercotac connectors: the electrical conduction path is a liquid metal that is molecularly bonded to the contacts. This creates a connection that is constant and unchanged for the life of the connector.



Rotating Electrical Connectors
Superior Connections for a World in Motion

SINGLE CONDUCTOR

1 Conductor, 10 Amp

Model 110

MODEL NO.	CONDUCTORS	DESCRIPTION	VOLTAGE AC/DC	AMP RATING AT 240 VAC	MAX FREQ. MHz	CONTACT RESISTANCE	MAX OP. RPM	TEMPERATURE Max. F (C) / Min. F (C)	ROTATION Torque (gm-cm)	CIRCUIT SEPARATION
110	1	Standard Model	N/A	10	200	<1m?	3600	140(60)/-20(-29)	35	N/A
110-SS	1	Stainless Steel Bearing	N/A	10	200	<1m?	3600	140(60)/-20(-29)	35	N/A
110-L	1	Low Torque	N/A	10	200	<1m?	1200	140(60)/-20(-29)	10	N/A

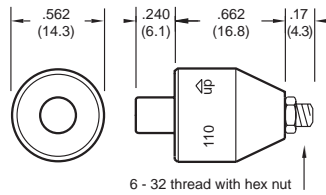

Inch (mm)

Accessories



5920 one contact receptacle



5921-S one contact receptacle w/ 6" wire



5952 one contact cap w/solder lug



55337 ring terminal (12-10 AWG)

Receptacle used for mounting to rotating device.

Accessories required for wire connections. Order Separately

1 Conductor, 10 Amp

Model 110-T

MODEL NO.	CONDUCTORS	DESCRIPTION	VOLTAGE AC/DC	AMP RATING AT 240 VAC	MAX FREQ. MHz	CONTACT RESISTANCE	MAX OP. RPM	TEMPERATURE Max. F (C) / Min. F (C)	ROTATION Torque (gm-cm)	CIRCUIT SEPARATION
110-T	1	Standard Model	N/A	10	200	<1m?	3600	140(60)/-20(-29)	35	N/A
110-TS	1	Stainless Steel Bearing	N/A	10	200	<1m?	3600	140(60)/-20(-29)	35	N/A
110-TL	1	Low Torque	N/A	10	200	<1m?	1200	140(60)/-20(-29)	10	N/A
105	1	High Temp. High RPM	N/A	4	200	<1m?	Call for Specifications		N/A	
105-SS	1	Stainless Steel Bearing	N/A	4	200	<1m?	Call for Specifications		N/A	

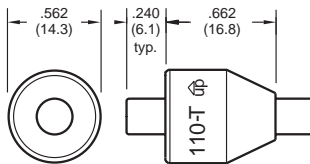

Inch (mm)

Accessories



5920 one contact receptacle



5921-S one contact receptacle w/ 6" wire



5952 one contact cap w/solder lug

Receptacle used for mounting to rotating device.

Accessories required for wire connections. Order Separately

1 Conductor, 250 Amp

Model 1250

MODEL NO.	CONDUCTORS	DESCRIPTION	VOLTAGE AC/DC	AMP RATING AT 240 VAC	MAX FREQ. MHz	CONTACT RESISTANCE	MAX OP. RPM	TEMPERATURE Max. F (C) / Min. F (C)	ROTATION Torque (gm-cm)	CIRCUIT SEPARATION
1250	1	Standard Model	N/A	250	200	<1m?	1200	140(60)/-20(-29)	250	N/A
1250-SS	1	Stainless Steel Bearing	N/A	250	200	<1m?	1200	140(60)/-20(-29)	250	N/A
1250-M	1	Metric Thread (10x1.5)	N/A	250	200	<1m?	1200	140(60)/-20(-29)	250	N/A
1250-MS	1	Metric Thread & Stainless Steel Bearing	N/A	250	200	<1m?	1200	140(60)/-20(-29)	250	N/A
1250-SX	1	Stainless Steel Body & Bearing	N/A	250	200	<1m?	1200	140(60)/-20(-29)	250	N/A
1250-MSX	1	Metric Thd., Stainless Steel Body & Bearing	N/A	250	200	<1m?	1200	140(60)/-20(-29)	250	N/A

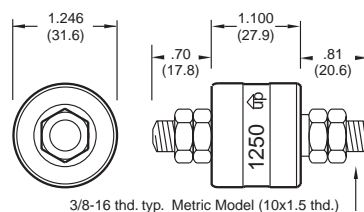

Accessories



57125 Boot Kit For dust and splash protection IP51

2 Conductors, 4 Amp

Model 205

MODEL NO.	CONDUCTORS	DESCRIPTION	VOLTAGE AC/DC	AMP RATING AT 240 VAC	MAX FREQ. MHz	CONTACT RESISTANCE	MAX OP. RPM	TEMPERATURE Max. F (C) / Min. F (C)	ROTATION Torque (gm-cm)	CIRCUIT SEPARATION
205	2	Standard Model	0-250	4	200	<1m	2000	140(60)/45(7)	75	>25M
205-SS	2	Stainless Steel Bearing	0-250	4	200	<1m	2000	140(60)/45(7)	75	>25M
205-L	2	Low Torque/Low Temp.	0-250	4	200	<1m	1200	140(60)/-20(-29)	20	>25M
205-LS	2	Low Temp. Stainless Steel Bearing	0-250	4	200	<1m	1200	140(60)/-20(-29)	75	>25M
205-H	2	High RPM	0-250	4	200	<1m	3600	140(60)/45(7)	35	>25M
205-HS	2	High RPM, Stainless steel bearing	0-250	4	200	<1m	3600	140(60)/45(7)	35	>25M

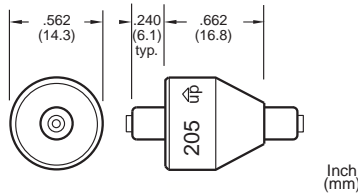

Accessories

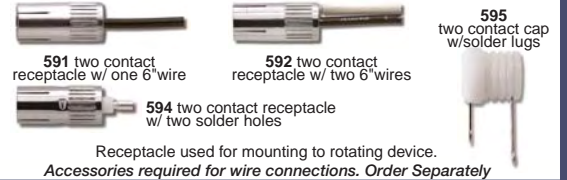

2 Conductors, 30 Amp

Model 230

MODEL NO.	CONDUCTORS	DESCRIPTION	VOLTAGE AC/DC	AMP RATING AT 240 VAC	MAX FREQ. MHz	CONTACT RESISTANCE	MAX OP. RPM	TEMPERATURE Max. F (C) / Min. F (C)	ROTATION Torque (gm-cm)	CIRCUIT SEPARATION
230	2	Standard Model	0-250	30	200	<1m	1800	140(60)/-20(-29)	200	>25M
230-SS	2	Stainless Steel Bearing	0-250	30	200	<1m	1800	140(60)/-20(-29)	200	>25M

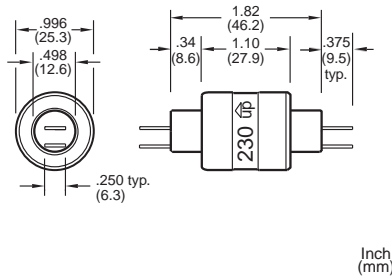

Accessories

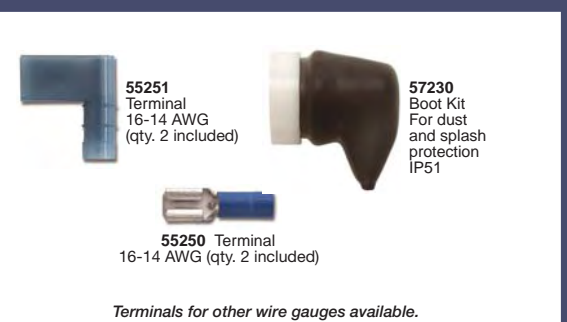

3 Conductors, 4 Amp

Model 305

MODEL NO.	CONDUCTORS	DESCRIPTION	VOLTAGE AC/DC	AMP RATING AT 240 VAC	MAX FREQ. MHz	CONTACT RESISTANCE	MAX OP. RPM	TEMPERATURE Max. F (C) / Min. F (C)	ROTATION Torque (gm-cm)	CIRCUIT SEPARATION
305	3	Stainless Steel Bearing Standard	0-250	4	200	<1m	1800	140(60)/45(7)	100	>25M
305-L	3	Low Temperature	0-250	4	200	<1m	1000	140(60)/-20(-29)	100	>25M

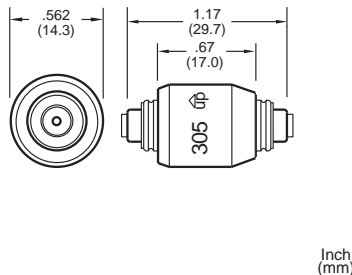

Accessories

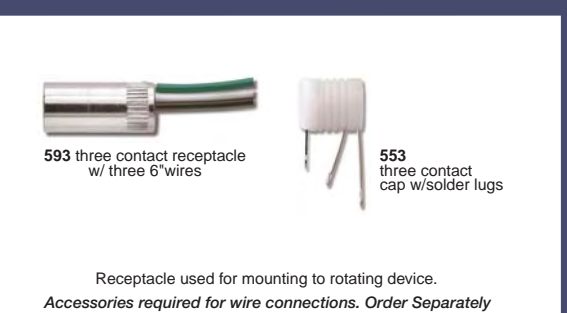

3 Conductors, Combination 4 Amp & 30 Amp

Model 331

MODEL NO.	CONDUCTORS	DESCRIPTION	VOLTAGE AC/DC	AMP RATING AT 240 VAC	MAX FREQ. MHz	CONTACT RESISTANCE	MAX OP. RPM	TEMPERATURE Max. F (C) / Min. F (C)	ROTATION Torque (gm-cm)	CIRCUIT SEPARATION
331	3	Standard Model	0-250	2@4/1@30	100	<1m?	1800	140(60)/-20(-29)	200	>25M?
331-SS	3	Stainless Steel Bearing	0-250	2@4/1@30	100	<1m?	1800	140(60)/-20(-29)	200	>25M?

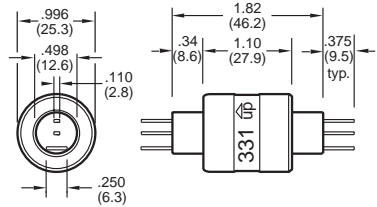

Inch (mm)

Accessories



55251 Terminal 16-14 AWG (qty. 1 included)



57230 Boot Kit For dust and splash protection IP51



55250 Terminal 16-14 AWG (qty. 1 included)



55110 Terminal 22-18 AWG (qty. 4 included)

Terminals for other wire gauges available.

3 Conductors, 30 Amp

Model 330

MODEL NO.	CONDUCTORS	DESCRIPTION	VOLTAGE AC/DC	AMP RATING AT 240 VAC	MAX FREQ. MHz	CONTACT RESISTANCE	MAX OP. RPM	TEMPERATURE Max. F (C) / Min. F (C)	ROTATION Torque (gm-cm)	CIRCUIT SEPARATION
330	3	Standard Model	0-250	30	100	<1m?	1200	140(60)/-20(-29)	300	>25M?
330-SS	3	Stainless Steel Bearing	0-250	30	100	<1m?	1200	140(60)/-20(-29)	300	>25M?

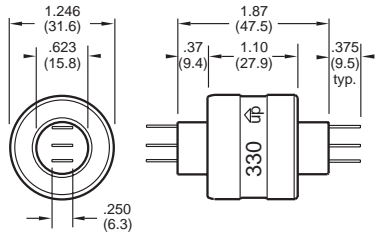

Inch (mm)

Accessories



55251 Terminal 16-14 AWG (qty. 3 included)



57430 Boot Kit For dust and splash protection IP51



55253 Shrink Tube (qty. 3 included)



55252 Terminal 16-14 AWG (qty. 3 included)

Terminals for other wire gauges available.

4 Conductors, Combination 4 Amp & 30 Amp

Model 430

MODEL NO.	CONDUCTORS	DESCRIPTION	VOLTAGE AC/DC	AMP RATING AT 240 VAC	MAX FREQ. MHz	CONTACT RESISTANCE	MAX OP. RPM	TEMPERATURE Max. F (C) / Min. F (C)	ROTATION Torque (gm-cm)	CIRCUIT SEPARATION
430	4	Standard Model	0-250	2@4/2@30	100	<1m?	1200	140(60)/-20(-29)	400	>25M?
430-SS	4	Stainless Steel Bearing	0-250	2@4/2@30	100	<1m?	1200	140(60)/-20(-29)	400	>25M?

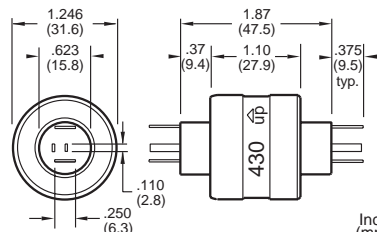

Inch (mm)

Accessories

50431 Plug Assembly 12 in. wires, 14 AWG & 18 AWG Suitable for up to 20 Amps



57430 Boot Kit For dust and splash protection IP51

50430 Plug Kit no wires, terminals for wire gauges 20-16 AWG & 16-14 AWG Suitable for up to 20 Amps Also order 5030-T

55110 qty 4, 22-18 AWG



55251 qty 2, 16-14 AWG



5030-T Plug Terminal Crimping Tool

55250 qty 2, 16-14 AWG

4, 6 & 8 CONDUCTORS

Model 435

MODEL NO.	CONDUCTORS	DESCRIPTION	VOLTAGE AC/DC	AMP RATING AT 500 VAC	MAX FREQ. MHz	CONTACT RESISTANCE	MAX OP. RPM	TEMPERATURE Max. F (C) / Min. F (C)	ROTATION Torque (gm-cm)	CIRCUIT SEPARATION
435	4	High Voltage Model	0-500	30	100	<1m?	300	140(60)/-20(-29)	850	>50M?
435-SS	4	High Voltage Stainless Steel Bearing	0-500	30	100	<1m?	300	140(60)/-20(-29)	850	>50M?

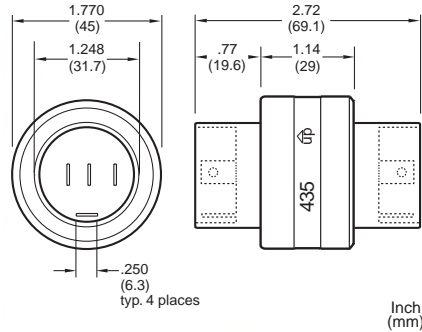

Accessories



Terminals for other wire gauges available.

Model 630

MODEL NO.	CONDUCTORS	DESCRIPTION	VOLTAGE AC/DC	AMP RATING AT 240 VAC	MAX FREQ. MHz	CONTACT RESISTANCE	MAX OP. RPM	TEMPERATURE Max. F (C) / Min. F (C)	ROTATION Torque (gm-cm)	CIRCUIT SEPARATION
630	6	Standard Model	0-250	2@4/4@30	100	<1m?	300	140(60)/-20(-29)	700	>25M?
630-SS	6	Stainless Steel Bearing	0-250	2@4/4@30	100	<1m?	300	140(60)/-20(-29)	700	>25M?

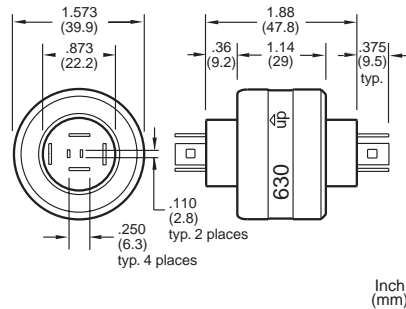

Accessories

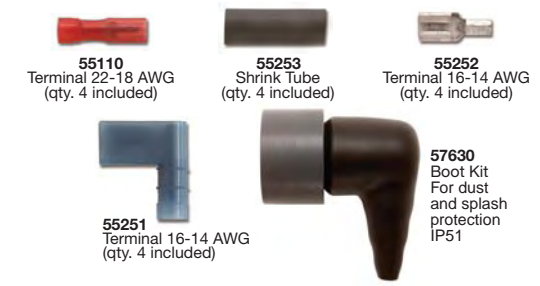

Terminals for other wire gauges available.

Model 830

MODEL NO.	CONDUCTORS	DESCRIPTION	VOLTAGE AC/DC	AMP RATING AT 240 VAC	MAX FREQ. MHz	CONTACT RESISTANCE	MAX OP. RPM	TEMPERATURE Max. F (C) / Min. F (C)	ROTATION Torque (gm-cm)	CIRCUIT SEPARATION
830	8	Standard Model	0-250	2@4/6@30	100	<1m?	200	140(60)/-20(-29)	1000	>25M?
830-SS	8	Stainless Steel Bearing	0-250	2@4/6@30	100	<1m?	200	140(60)/-20(-29)	1000	>25M?

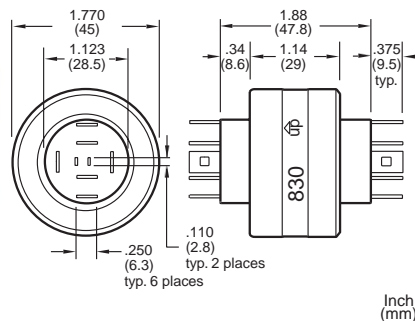

Accessories

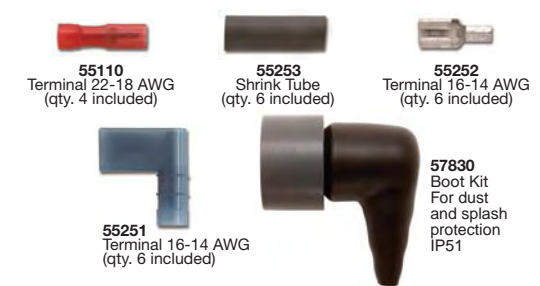

Terminals for other wire gauges available.

MOUNTING

- Mercotac connectors may be used in any position between vertical and 90 horizontal. The UP arrow should not point below horizontal.
- The models 110, 110-T, 205, and 305 Mercotacs use the knurled receptacle inserted into the rotating member for mounting. This receptacle holds the Mercotac connector.
- Larger Mercotac connectors use either the body or the plastic collar for mounting to the rotating member.
- In horizontal applications, mount the connector with the body rotating to reduce mechanical loads on the bearing.
- Limit mounting eccentricity to a maximum of .005" TIR.
- Mercotac connectors are not designed to carry mechanical loads. One end should be allowed to float, attached only by the connecting wires.

CONNECTION

- Use stranded wires of ample length and flexibility for the Mercotac connection in order to avoid mechanical loads.
- Terminal Accessories are push-on quick disconnects which crimp onto the connecting wires and push onto the Mercotac connector tabs.
- Do not solder wires to the connector or bend tabs as such misuse will cause connector failure and void the warranty.
- Provide overload protection to the electrical circuit containing the Mercotac connector.
- If wire wrapping occurs from too much connector torque, it is suggested to use a torque arm positioned to float against a fixed stop.

TEMPERATURE

- Provide thermal insulation where necessary to prevent the Mercotac temperature from exceeding 140F (60C). Mercotac connectors contain plastic materials which are sensitive to heat.
- Overheating will cause connector failure and voids the warranty.

VIBRATION/ SHOCK

- Vibration or mechanical shock will reduce connector life or cause failure.
- If vibration or shock is present, we suggest a flexible isolating mounting.

FOOD APPLICATIONS

- Mercotac connectors are factory sealed but do contain mercury and other fluids.
- As a precaution, a protective housing is suggested to isolate the rotating connector from the food product.

BOOT KIT

- The boot kit is not watertight or intended for waterproofing but is designed to give protection to the wire terminals from splashing water or dust. The protection rating is IP51.

RECYCLING

Mercotac connectors contain mercury and should not be disposed of in the trash but only through mercury recycling programs. Mercotac Inc. offers a mercury recycling service for this purpose. Ship spent connectors to our Carlsbad facility by UPS ground enclosed in a plastic bag. Include paperwork stating, "for recycling" with your company name, phone and fax numbers. Do not send through the US mail.

Suggested Mounting Methods

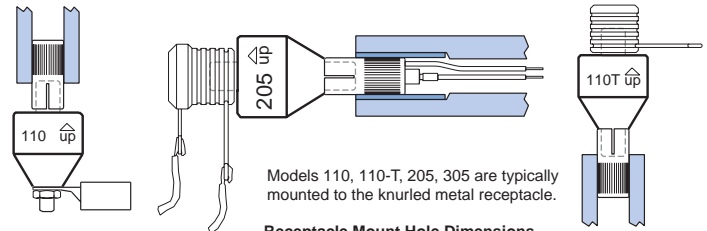

Models 110, 110-T, 205, 305 are typically mounted to the knurled metal receptacle.

Receptacle Mount Hole Dimensions

MODEL	HOLE DIAMETER Ø	DEPTH
591, 592, 5920, 594	.283" (7.19)	.35" (8.89)
593	.408" (10.36)	.35" (8.89)

Inch (mm) Tolerances Ø $+0.011^{(+.025)}$
 $-0.000^{(-.000)}$

Typical Body Mount

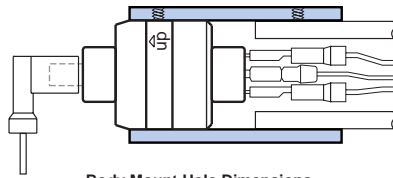

Body Mount Hole Dimensions

MODEL	HOLE DIAMETER Ø	DEPTH*
230, 331	.998" (25.35)	.80" (20)
330, 430, 1250	1.248" (31.70)	.80" (20)
630	1.575" (40.00)	.80" (20)
435, 830	1.772" (45.00)	.80" (20)

Inch (mm) Tolerances Ø $+0.011^{(+.025)}$
 $-0.000^{(-.000)}$
*Minimum additional depth for disconnects clearance 1.4" (35.5)

Typical Collar Mount

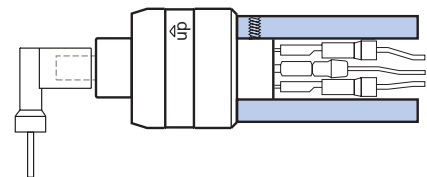

Collar Mount Hole Dimensions

MODEL	HOLE DIAMETER Ø	DEPTH*
230, 331	.500" (12.70)	.40" (10)
330, 430	.625" (15.88)	.40" (10)
430 w/plug	.625" (15.88)	1.40" (36)
630	.875" (22.23)	.40" (10)
830	1.125" (28.58)	.40" (10)
435	1.250" (31.75)	.80" (20)
1250 Stud	3/8"-16 UNC	.81" (20.5)
1250-M Stud	10X1.5 metric	.81" (20.5)

Inch (mm) Tolerances Ø $+0.011^{(+.025)}$
 $-0.000^{(-.000)}$
*Minimum additional depth for disconnects clearance 1.4" (35.5)

Insulating Collar Mount

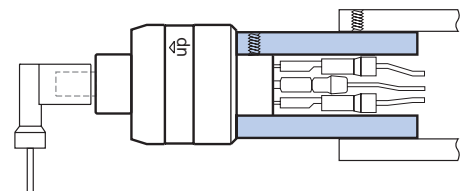

Mounting with an insulating collar may be required to insulate connector from conducted heat. Soft-mounting with rubber type material is needed if unit will be subjected to vibration.



*Mercotac connectors are manufactured in Carlsbad, California. U.S.A
Mercotac Inc. has been making superior connectors for over 25 years.
In the U.S.A. they may be purchased directly from the factory.
Mercotac connectors are sold worldwide by Authorized Distributors.*

MOD-TRONIC
INSTRUMENTS LIMITED

1 Delta Park Blvd, #12 Brampton, ON L6T 5G1
Tel 905-457-6322 or 1-800-794-5883
Fax 905-457-4716 or 1-800-830-7122
sales@mod-tronic.com www.mod-tronic.com